

Rebuild Instructions

Universal Black Drum Unit Rebuild Kit for use in Konica Minolta bizhub 552, 652, C452, C552, C652 series (DR-612K Drum Unit) and bizhub 654, 754, C654, C754 series (DR-711K Drum Unit)

Instructions relatives au reconditionnement
Anweisungen zur Grunderneuerung
Istruzioni di ricondizionamento
Instruções de reconstrução
Instrucciones de reconstrucción

Rebuild Kit Contents:

(1) OPC Drum (1) Drum Cleaning blade (1) Main Charger Kit (1) Black Drum Unit Reset Chip

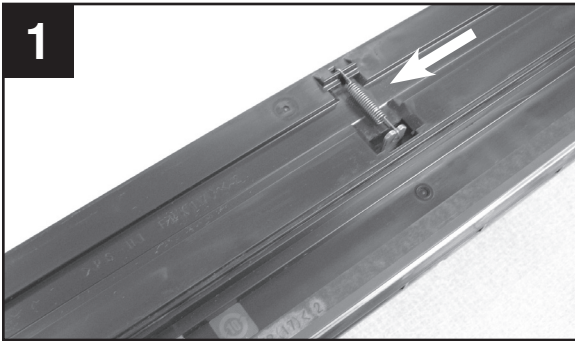

Remove the drum cleaning blade tension spring.

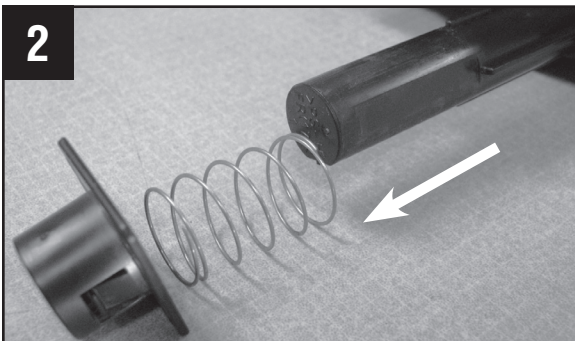

Remove waste toner port cover and spring.

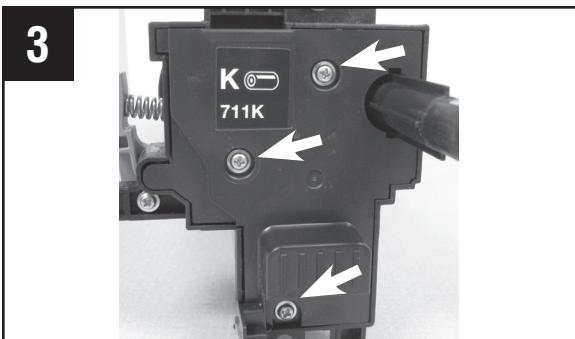

Remove the screws securing the front cover.

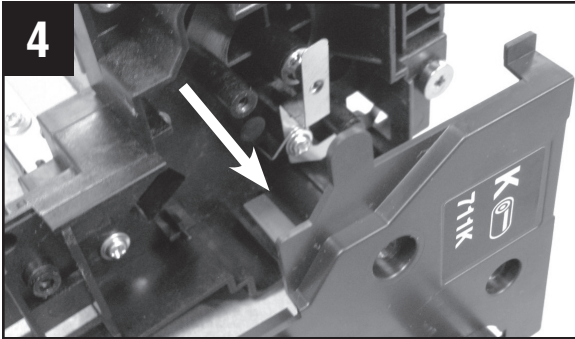

Remove the front cover.

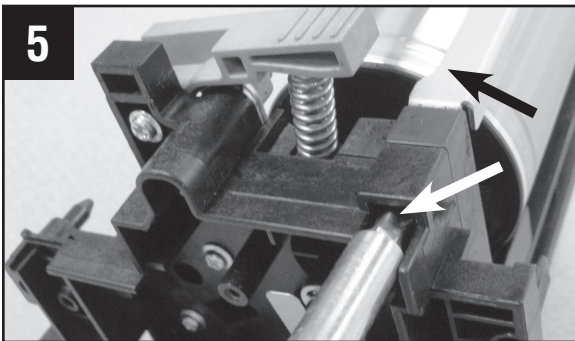

Remove the front screw securing the small metal side bracket.

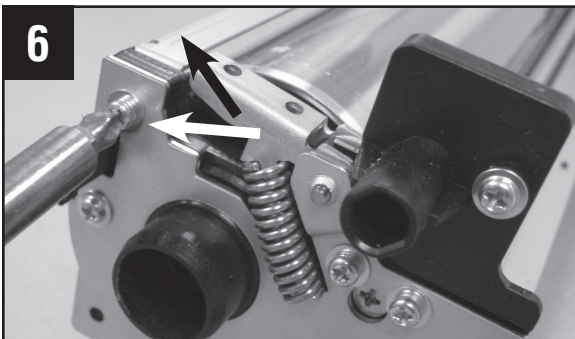

Remove the rear screw securing the small metal side bracket.

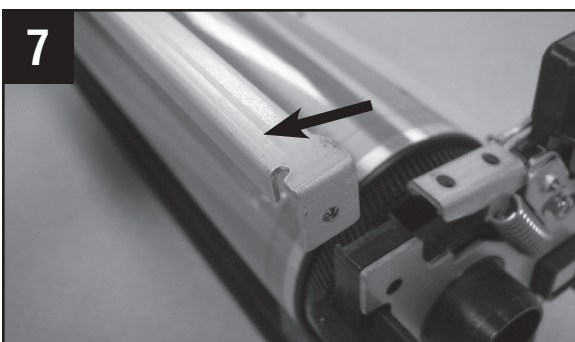

Remove small metal side bracket.

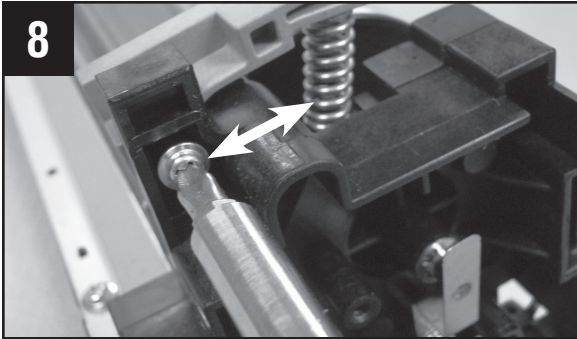

Loosen the screw to release the latch spring tension.

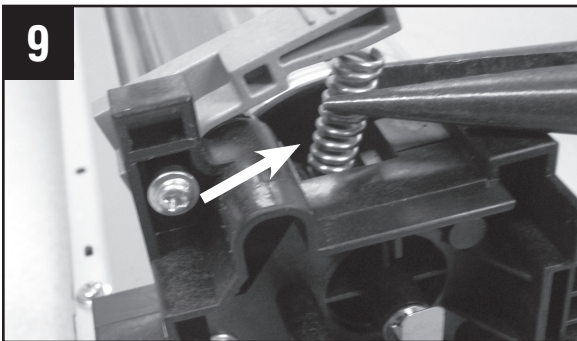

Remove the spring.

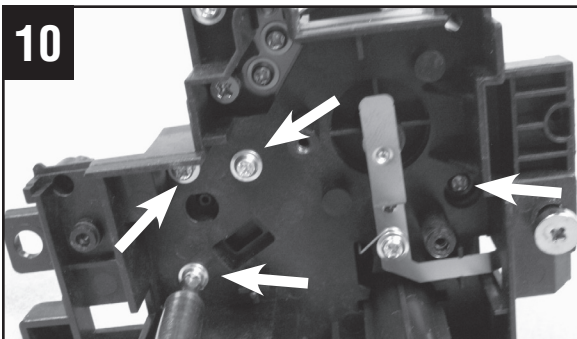

Remove 4 screws from inner front frame.

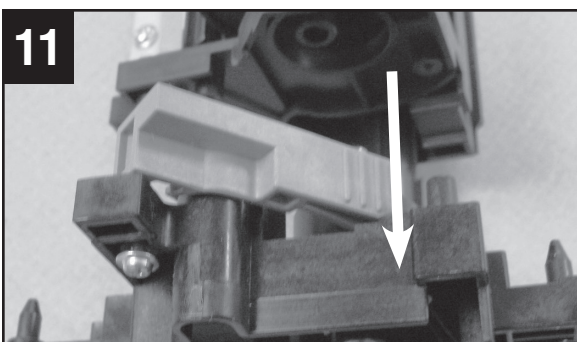

Remove the inner front frame.

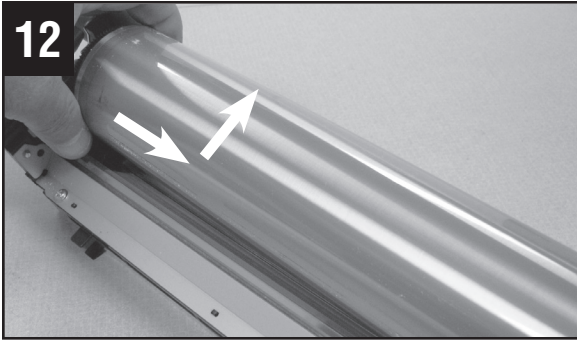

Slide the used OPC drum towards the front and lift out to remove.

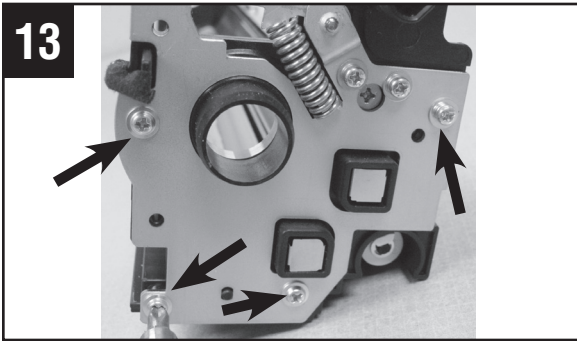

Remove 4 screws from rear frame plate.

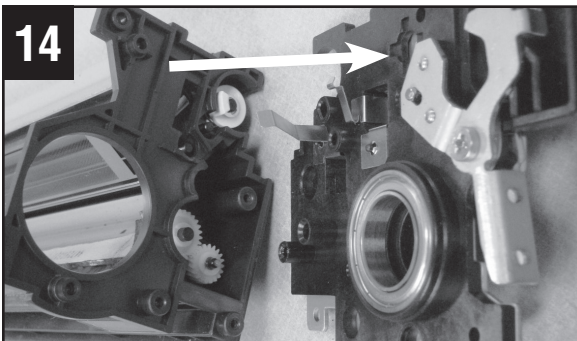

Remove the rear frame plate.

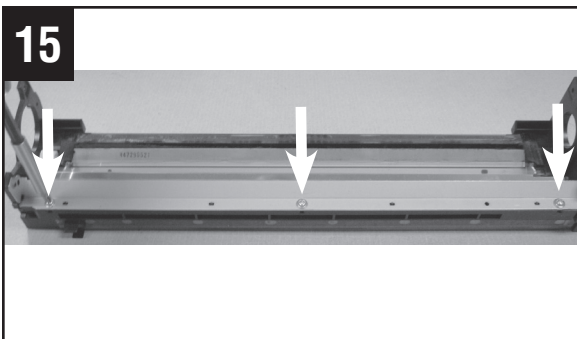

Remove the screws securing the metal side bracket.

16

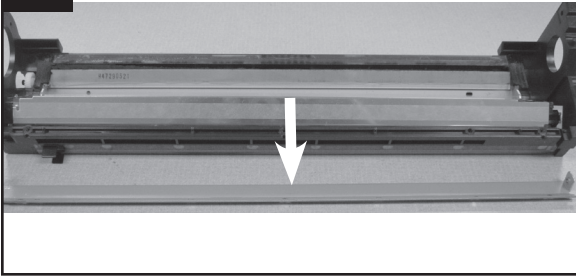

Remove the metal side bracket.

17

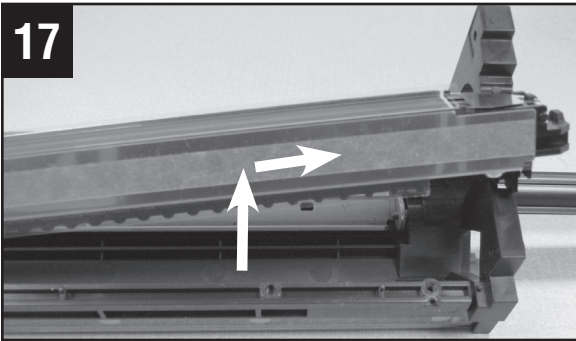

Remove the charge corona unit.

18

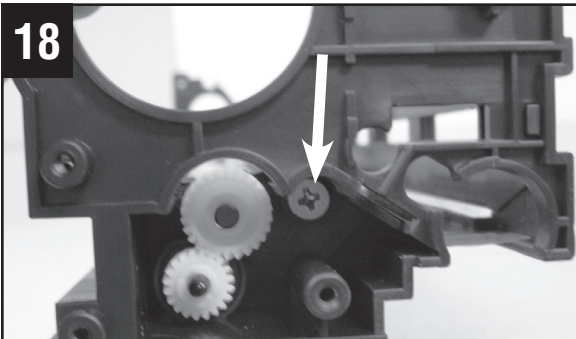

Remove the rear drum cleaning blade shoulder screw.

19

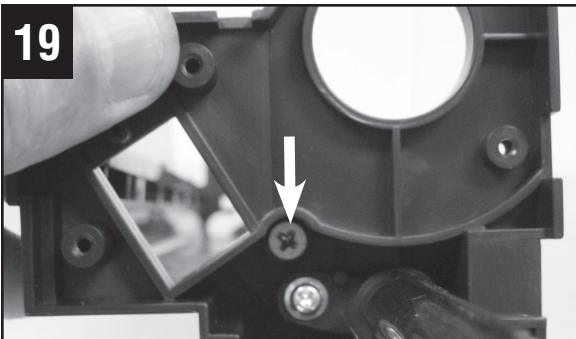

Remove the front drum cleaning blade shoulder screw.

20

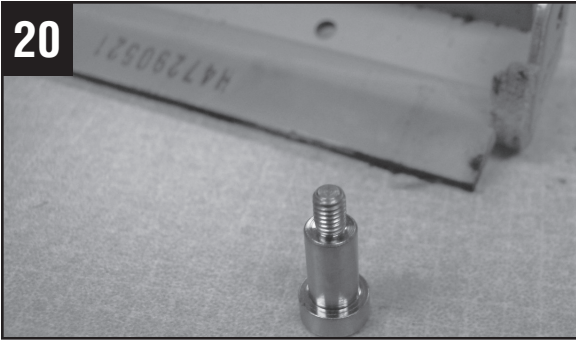

Remove the used drum cleaning blade (1 shoulder screw shown).

21

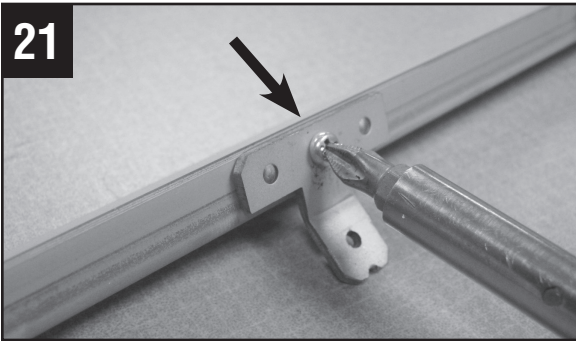

Remove the spring tension bracket from the used cleaning blade.

22

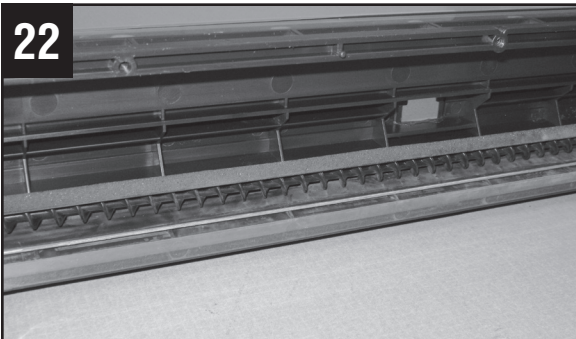

Vacuum and clean the cleaning unit and drum unit frame.

23

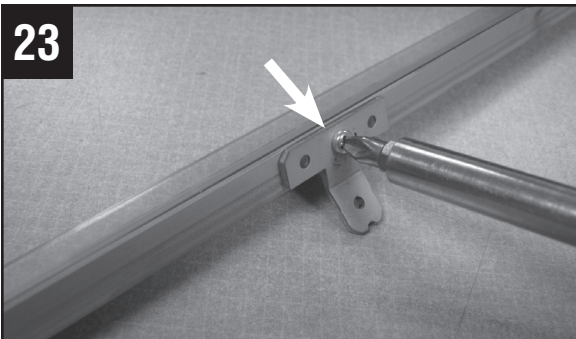

Attach the spring tension bracket on the new cleaning blade bracket.
Apply lubricant to the edge of the new cleaning blade.

24

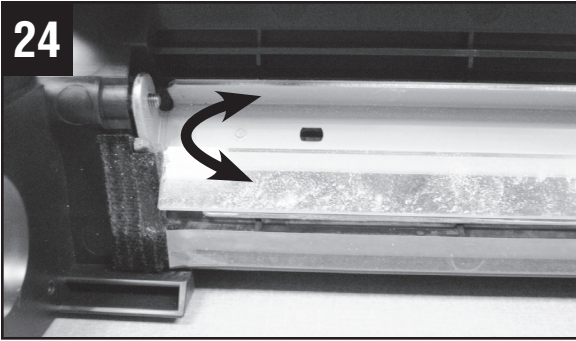

Position and secure the new cleaning blade into the drum unit frame. Confirm proper pivot movement of the cleaning blade.

25

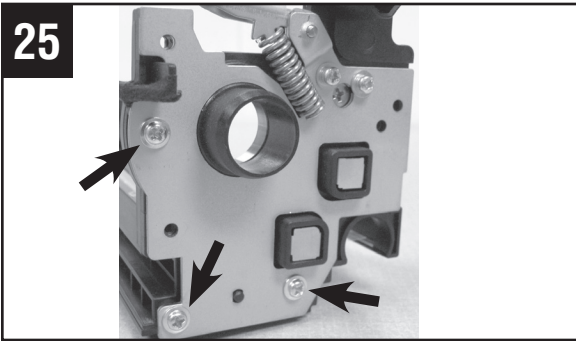

Position and secure the rear frame plate with 3 screws.

26

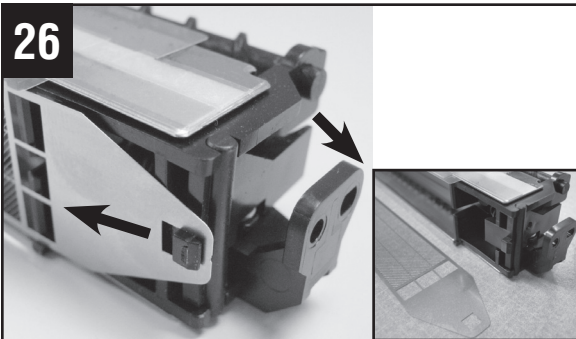

Remove the old charge screen grid mesh. Release the spring tension by lifting on the pivot bracket.

27

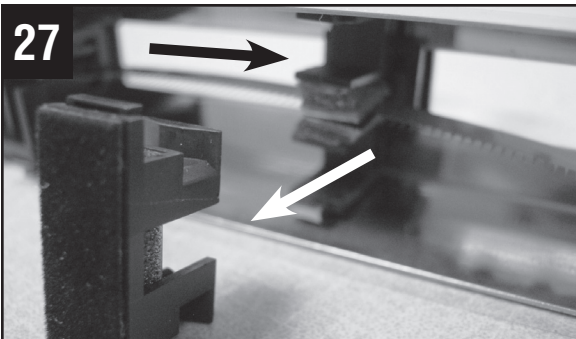

Reposition the corona cleaner away from the corona end block. Detach the charge screen grid mesh cleaner.

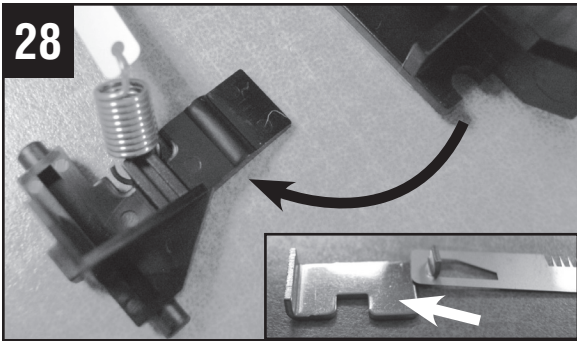

28 Remove the comb electrode by removing the spring tension pivot bracket from the corona end block.
Remove the metal bracket from the opposite end of the corona end block.

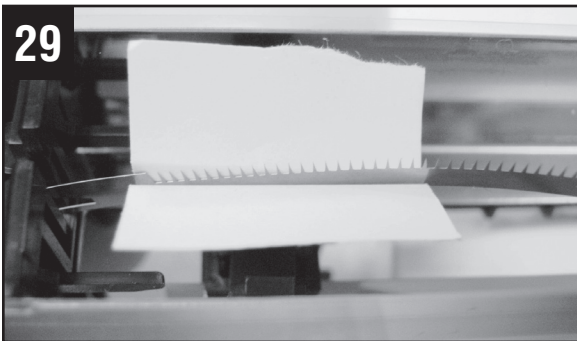

29 Fold a small piece of paper and position in the comb electrode pinch cleaner. The paper will aid in installing the new comb electrode. Connect metal bracket to new comb electrode and position in end block.

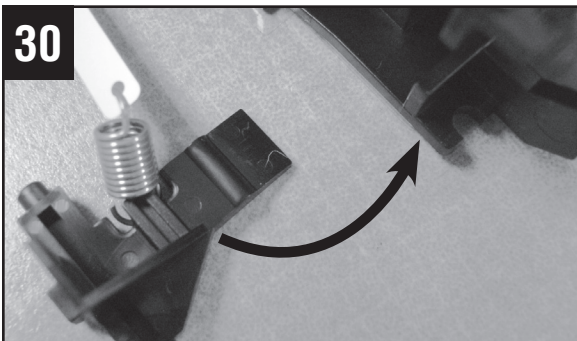

30 Connect the tension spring to the new comb electrode and reposition the pivot bracket in the corona end block.



31 Remove the paper guide used in step 29 from the comb electrode pinch cleaner. Install the charge screen grid mesh cleaner.

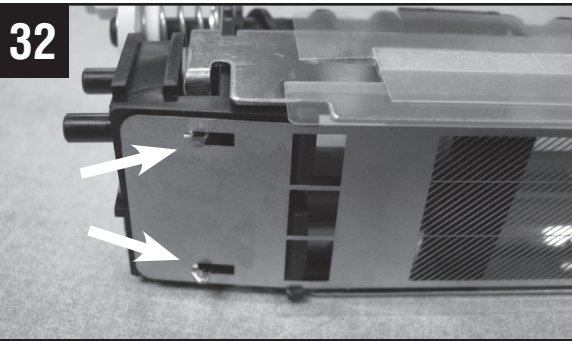

Attach the new charge screen grid mesh on the corona end block.

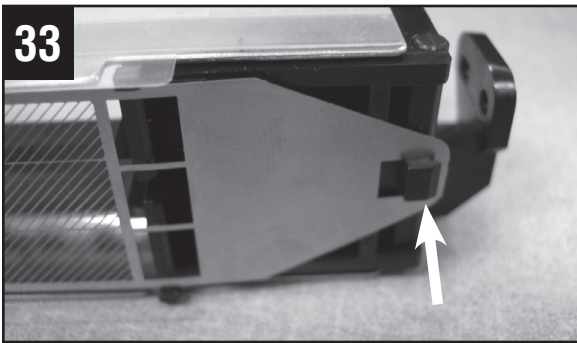

Release the spring tension and attach the screen grid mesh to the pivot bracket. Reposition the corona cleaner back to home position.

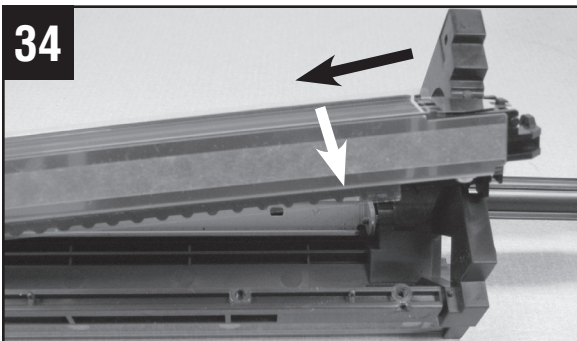

Install the charge corona unit into the drum unit frame.

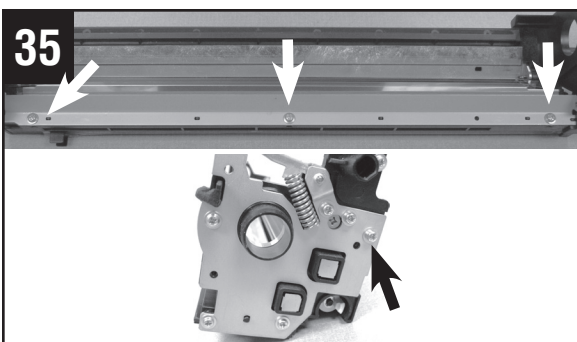

Reposition and secure the metal side bracket.

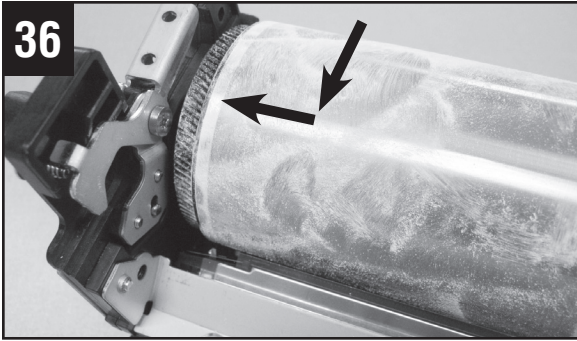

Carefully position the new OPC drum into the drum unit frame.

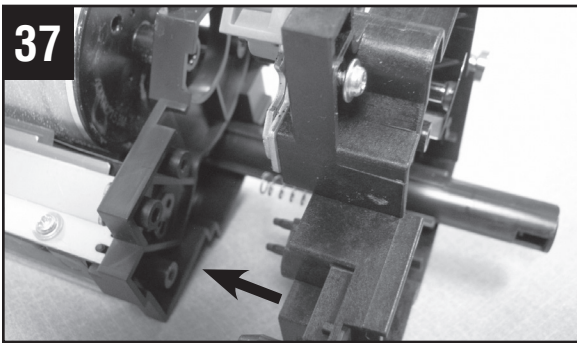

Slide inner front frame on drum unit while aligning the OPC drum pin and charge corona unit positioning pins.

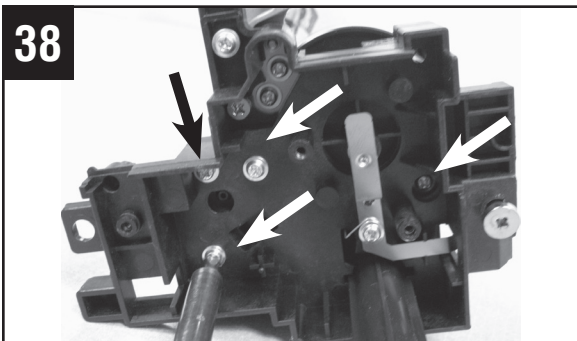

Secure inner front frame to drum unit frame using 4 screws.

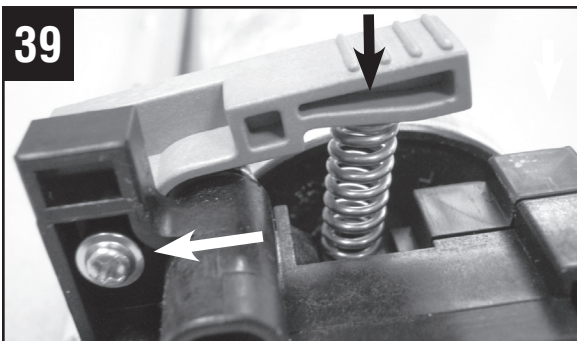

Position latch spring. Compress latch and tighten stop screw.

40

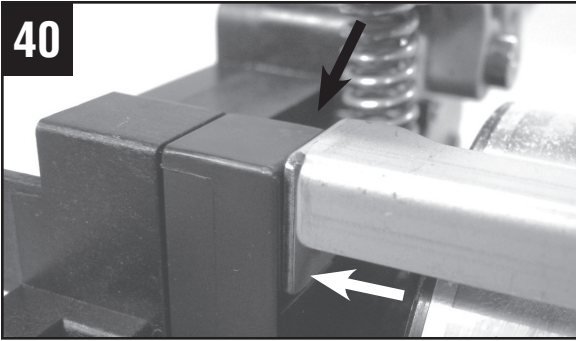

Reposition the small metal side bracket.
Secure bracket with the 2 screws removed in step 5 and 6.

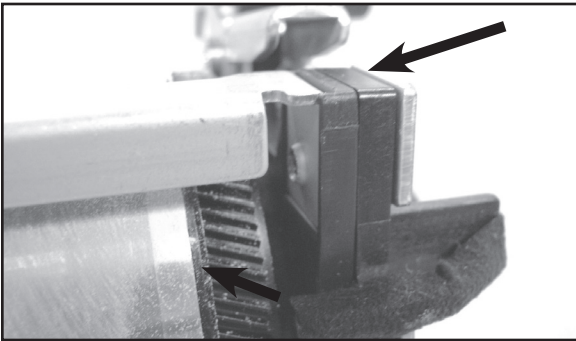

41

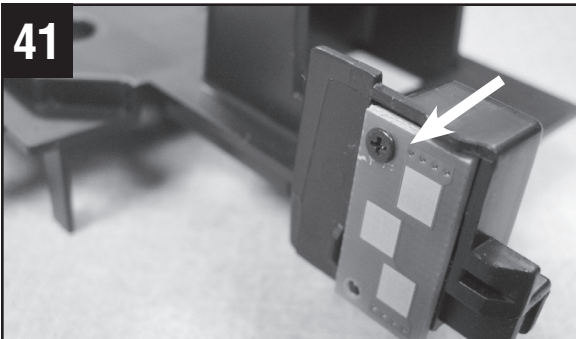

Install the new reset chip on the front cover.

42

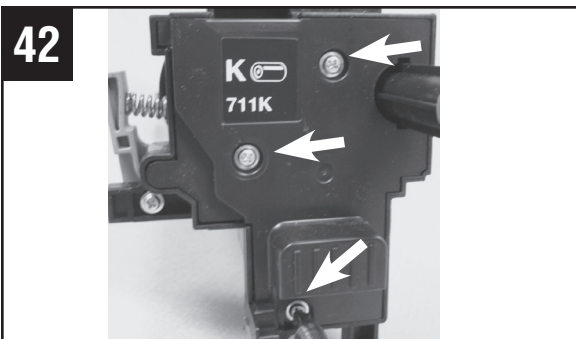

Install the front cover and secure with the 3 screws removed in step 3.

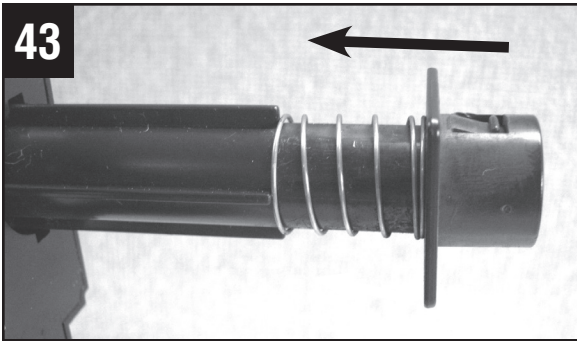

Install the waste toner port spring and cover.

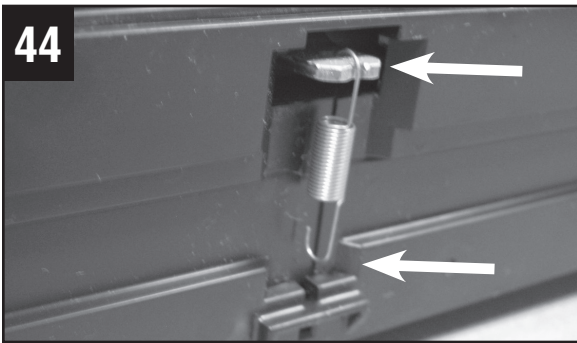

Install the drum cleaning blade tension spring.

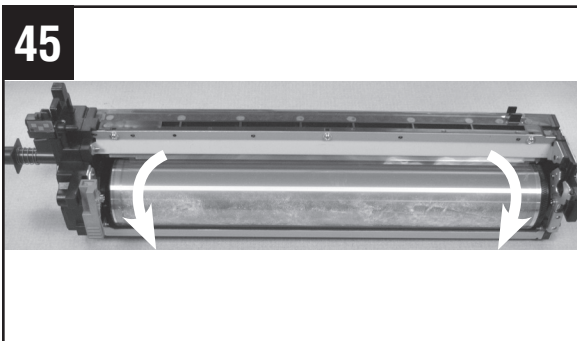

Manually rotate the OPC drum in the direction shown to clean lubricating powder from drum surface. Rotate OPC near the ends, do not touch the OPC coating.